



USER MANUAL

Determined to be a leading provider of energy storage products



Wall Mounted Battery Packs-100AH

Choicell New Energy Technology GmbH

Address: Basler Str.361352 Bad HomburgGermany

telephone: 01639368986

e-mail: s.dai@choicell.de

contents

1.TECHNICAL DATA	01
2.PRODUCT OVERVIEW	03
2.1 brief introduction	03
2.2 Interface Introduction	04
2.2.1 Switch ON/OFF	04
2.2.2 Interface Introduction	05
2.2.3 Explanation of LED light changes	06
2.2.4 Power indicator light description	06
3.INSTALLATION GUIDE	07
3.1 Checking Before Installation	07
3.1.1 Checking Outer Packing Materials	07
3.1.2 Cheeking Deliverables	07
3.2 Tools	09
3.3 Installation requirements	10
3.3.1 Installation environment requirements	10
3.3.2 Installation carrier requirements	10
4.MAINTENANCE	13
4.1 Recharge Requirements During Normal Storage	13
4.2 Recharge Requirements When Over Discharged	14

01

TECHNICAL DATA

note

Operating current derating according to cell

Voltage and battery temperature

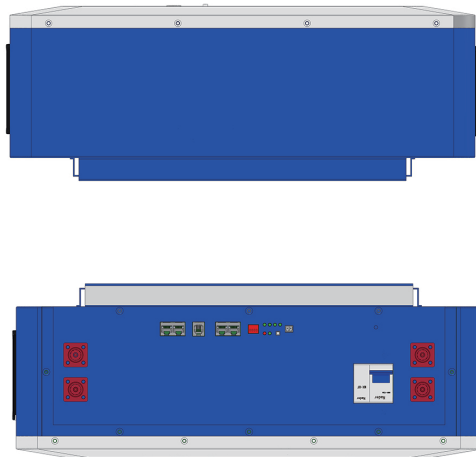

Power supply model	LF-WPS-51.2V100AH
Nominal voltage	51.2V
Nominal capacity	100Ah/5.12KWh
Recommended Charge Voltage	56.8V
Discharge cut-off voltage	46.4V
Recommended charging current	≤50A
Maximum charging current	95A
Recommended discharge current	≤50A
Maximum discharge current	100A
Battery cycle life	≥5000cycle life @0.5C/0.5C (25±2)°C
Communication mode	R485/R232/CAN
Charging temperature	5~45°C
Operating temperature	-20~60°C
Battery weight	≈43.5kg
Battery size	548x480x204mm (adjustable)

*Can be customized according to the needs, the final interpretation of this product is owned by the company, subject to change without prior notice
*Please check according to your own product specifications

02

PRODUCT OVERVIEW

2.1 brief introduction

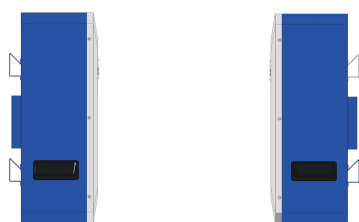

This product is made of 16 Iron(III) phosphate lithium battery cells in series,It is an advanced environmentally friendly household energy storage system,Fashionable design with high energy.long service life,Easy to install and expand.

With rich battery management experience and advanced Energy storage,LF-WHS-51.2V100AH Equipped with advanced intelligent Battery management system,The system adopts a modular design,ntegrating functions such as collection, monitoring,management,and communication,Achieved high-precision single voltage(10mv) / Current collection,- Can simultaneously monitor the environment,Temperature changes of battery cells and main heating devices.Extending the lifespan of battery cells and devices,Simultaneously equipped with intelligent charging balance,SOC,Power estimation,Data storage,charging current limiting protection module,LED color light bar display,Pre charging,RS232 communication,CAN communication,RS485 communication and other functions.

2.2 Interface Introduction

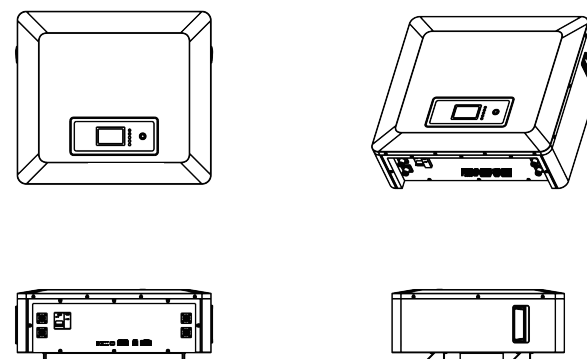

2.2.1 Switch ON/OFF

1.SWITCH ON

When used,Connect the load or inverter end wires to the output end of the battery pack first B+/B-,After confirming the wiring is completed, Turn on the power switch of the battery pack,The battery pack begins to supply power to the load for use.

2.SWITCH OFF

After use,Turn off the load and inverter switches first,Then turn off the battery pack switch.

2.2.2 Interface Introduction

System State	Running State	RUN	ALM	Battery Indicator LED				illustrate
		●	●	●	●	●	●	
Shutdown	Hibernate	OFF	OFF	OFF	OFF	OFF	OFF	Total extinction
Standby	Normal	flash1	OFF	Display based on battery level				position in readiness
	Warning	flash1	flash3	Display based on battery level				Example: Module undervoltage
Charge	Normal	Light	OFF	OFF	OFF	OFF	flash2	0~25% charge
		Light	OFF	OFF	OFF	flash2	Light	25~50% charge
		Light	OFF	OFF	flash2	Light	Light	50~75% charge
		Light	OFF	flash2	Light	Light	Light	75~100% charge
		Light	OFF	Light	Light	Light	Light	Charged
	Warning	Light	flash3	Display based on normal charging level				
	Protect	OFF	Light	Display based on normal charging level				
Discharge	Normal	flash3	OFF	Light	Light	Light	Light	100~75% charge
		flash3	OFF	OFF	Light	Light	Light	75~50% charge
		flash3	OFF	OFF	OFF	Light	Light	50~25% charge
		flash3	OFF	OFF	OFF	OFF	Light	25~0% charge
	Warning	flash3	flash3	Display based on normal discharge capacity				
	Overcurrent, short circuit, reverse connection, failure protection, etc	OFF	Light	OFF	OFF	OFF	OFF	Stop charging and discharging
Temperature	Normal	Normal indication based on status						
	Charging alarm	Light	flash3	According to the charging level indicator				Maximum LED flashing 2
	Discharge alarm	flash3	flash3	According to the discharge quantity indication				According to the constant light indication of the battery level
	Protect	OFF	Light	OFF	OFF	OFF	OFF	

2.2.3 Explanation of LED light changes

State		Charge				Discharge			
		L4	L3	L2	L1	L4	L3	L2	L1
Capacity indicator light		●	●	●	●	●	●	●	●
quantity of electricity (%)	0~25%	OFF	OFF	OFF	flash2	OFF	OFF	OFF	Light
	25~50%	OFF	OFF	flash2	Light	OFF	OFF	Light	Light
	50~75%	OFF	flash2	Light	Light	OFF	Light	Light	Light
	≥75%	flash2	Light	Light	Light	Light	Light	Light	Light
OperatiLight indicator ●		Light				flash			

2.2.4 Power indicator light description

Flashing mode	ON	OFF
flash 1	0.25s	3.75s
flash 2	0.5s	0.5s
flash 3	0.5s	1.5s

03

INSTALLATION GUIDE

-In stallation flow chart-

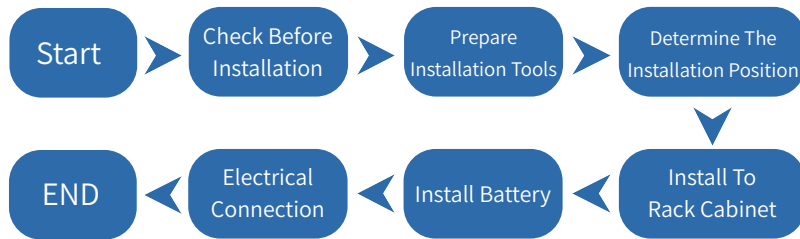

3.1 Checking Before Installation

3.1.1 Checking Outer Packing Materials

Packing materials and components may be damaged during transportation. Therefore, check the outer packing materials for damage, such as holes and cracks. If any damage is found, do not unpack the battery and contact the dealer as soon as possible. You are advised to remove the packing materials within 24 hours before installing the battery.

3.1.2 Cheeking Deliverables





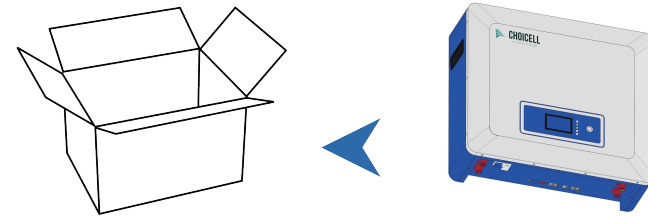





After unpacking the battery, check whether deliverables are intact and complete. If any damage is found or any component is missed, contact the dealer.

The below table shows the components and mechanical parts that should be delivered.



NO	Picture	Quantity	Description
1		1PCS	Battery
2		1PCS	Manual
3		1PCS	Communication
4		1PCS	Test Report
5		1PCS	Certificate of Conformity

3.2 Tools

Model	Tools		
Installation	 Knife	 Measuring tape	 Socket wrench (10/16mm)
	 Rubber mallet	 Cross Screwdriver	 Percussion drill (12mm)
Protection	 ESD gloves	 Safety goggles	 Anti-dust respirator
	 Safety shoes		

3.3 Installation requirements

3.3.1 Installation environment requirements

- *Install the battery in the indoor environment.
- *Place battery in secure location away from children and animals.
- *Do not place the battery near any heat sources and avoid sparks.
- *Do not expose the battery to moisture or liquids.
- *Do not expose the battery to direct sunlight.

3.3.2 Installation carrier requirements

- *Only mount battery on fire resistant building. Do not install batteries on flammable buildings.
- *Battery is quite heavy, make sure the wall/ground can meet the load bearing requirements.

STEP 1

Connect power cable

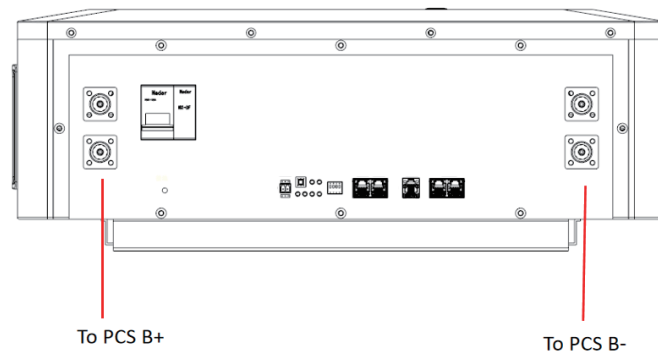

STEP 2

Connect communication cable

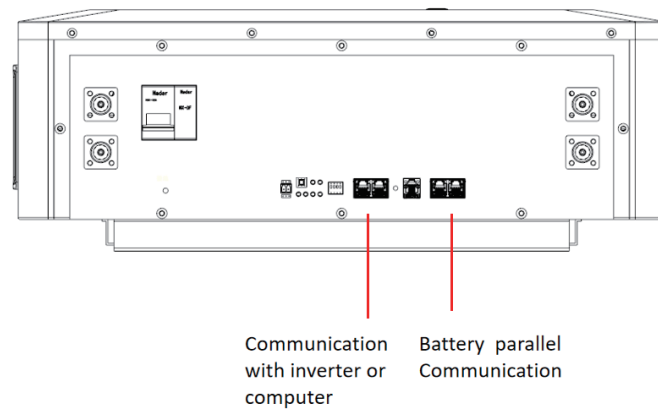

STEP 3

When multiple batteries are connected in parallel, follow the following wiring mode.

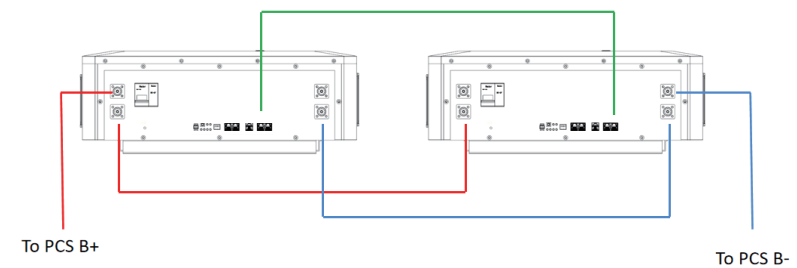

STEP 4

DIP Switch settings

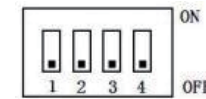

When the pack is used in parallel, Different packages can be distinguished by setting the address through the dial switch on the BMS, To avoid setting addresses to the same, Refer to the table below for the definition of BMS dial switch.

address	Dial switch position			
	#1	#1	#1	#1
1	ON	OFF	OFF	OFF
2	OFF	ON	OFF	OFF
3	ON	ON	OFF	OFF
4	OFF	OFF	ON	OFF
5	ON	OFF	ON	OFF
6	OFF	ON	ON	OFF
7	ON	ON	ON	OFF
8	OFF	OFF	OFF	ON
9	ON	OFF	OFF	ON
10	OFF	ON	OFF	ON
11	ON	ON	OFF	ON
12	OFF	OFF	ON	ON
13	ON	OFF	ON	ON
14	OFF	ON	ON	ON
15	ON	ON	ON	ON

04

MAINTENANCE

4.1 Recharge Requirements During Normal Storage

Battery should be stored in an environment with temperature range between -10°C~+45°C, and maintained regularly according to following table with 0.5C(25A) current till 40% SoC after long storage time.

Recharge Requirements During Normal Storage

Storage Environment Temperature	Relative Humidity of Storage Environment	Storage Time	SOC
Below -10°C	/	prohibit	/
-10~25°C	5%~70%	≤12 months	30%≤SOC≤60%
25~35°C	5%~70%	≤6 months	30%≤SOC≤60%
35~45°C	5%~70%	≤3 months	30%≤SOC≤60%
Above 45°C	/	prohibit	/

4.2 Recharge Requirements When Over Discharged

Over discharged (90%DoD) battery should be recharged according to following table, otherwise over discharged battery will be damaged.

Recharge Requirements During Normal Storage

Storage Environment Temperature	Storage Time	Note
-10~25°C	≤15 days	Battery Pack disconnected from PCS
-25~35°C	≤7 days	
-35~45°C	≤12 hours	Battery Pack connected to PCS