

1. Packing List

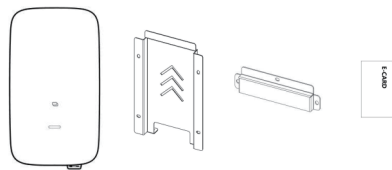

A B C D



E F G H

Object	Name	Qty
A	Charger	1
B	Mounting backplane	1
C	Mounting bracket	1
D	RFID card	2
E	Expansion Tube	4
F	Expansion Screw	4
G	Screw	5
H	Tubular terminal	5

2. Installation instructions

Note: The actual installation needs to comply with local installation requirements and local safety regulations.

Ensure that the wall or column is vertical or positive 15 ° before installation.

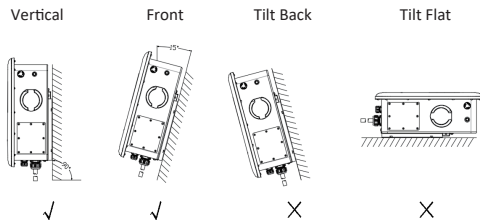

2.1 Wall-mounted installation method

1. Open the package and mark 4 holes in the wall ($\phi 8 * 50\text{mm}$).
2. Fit into the expansion tube.
3. Attach the mounting backplane with screws to the mounting wall.
4. Attach the bracket to the charger.
5. Hang the charger into the mounting back plate and screw it.
6. Installation completed.

Note: Installation wall thickness > 60mm

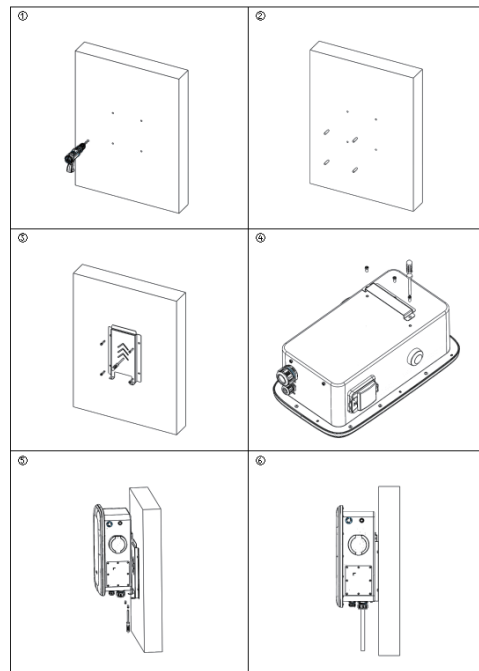

2.2 Floor type / Vertical installation method

1. Drill holes on the cement floor, four 170 * 120 holes with diameter $\phi 12\text{mm}$ deep 50mm screws and one $\phi 60\text{mm}$ through duct hole.
2. Install and fix the anchor screws.
3. The input line runs through the column hole, and then through the bottom of the column.
4. Install the backplane to the landing column with screws.
5. Attach the bracket to the charger.
6. Hang the charger into the mounting back plate and screw it well.
7. Installation completed.

Note: The angle of cement ground 90_{-0}^{+15}

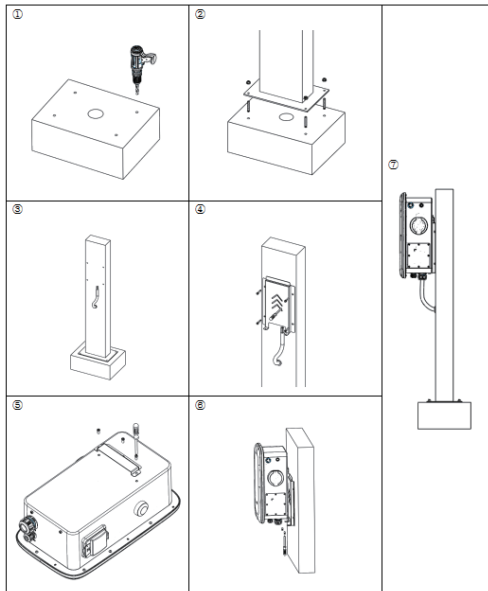

2.3 Electrical Connection

Step 1: Peel five L1, L2, L3, N and PE copper 16mm with wire stripping pliers, and press L1, L2, L3, N, PE and tube terminals with terminal pliers.

Step 2: Loosen the screw nut and puncture the hole.

Step 3: Open the side cover, load the cable (13-18mm) and tighten the gram head.

Step 4: Unscrew the terminal screws. Link L.N.PE line to lock the terminal screw and the side cover.

Note: Choose 10-12 AWG wire

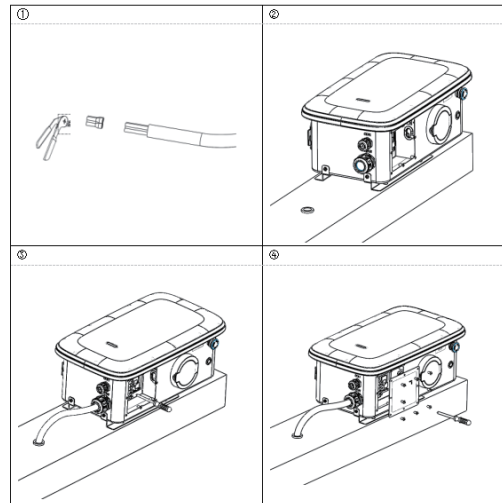

APP download

· Users can scan the QR code (Android and IOS) in the quick installation manual, or go to the App Store and Google Play to search for FoxSwitch.

Add RFID card

· Users can enter the White list of the charging pile on APP to add.

Please scan the QR Code and follow the steps below to download our latest multi-language User Manual/Quick Installation Guide:

Scan the QR Code → Select your Language → Choose to download User Manual or Quick Installation Guide → Download

Get the QR code of the user manual



Get QR code of APP

